



4-line filters for converters and power electronics

520/300 V ac, 50/60 Hz, 8...200 A, 50 °C

Ordering code: B84144A0008...A0200R120
Date: 2009-01-16
Version: 09

Construction

- 4–line filter
- Metal case

Features

- Easy to install
- Compact design
- Design complies with IEC 60939
- cULus, ENEC approval
- Optimized for long motor cable and operation under full load

Applications

- Frequency converters for motor drives, e.g.
 - elevators
 - pumps
 - traction systems
 - conveyor systems
 - HVAC systems (heating, ventilation and air conditioning)
- Power supplies

Terminals

- Line side: finger–safe terminal blocks
- Load side: finger–safe terminal blocks

Marking

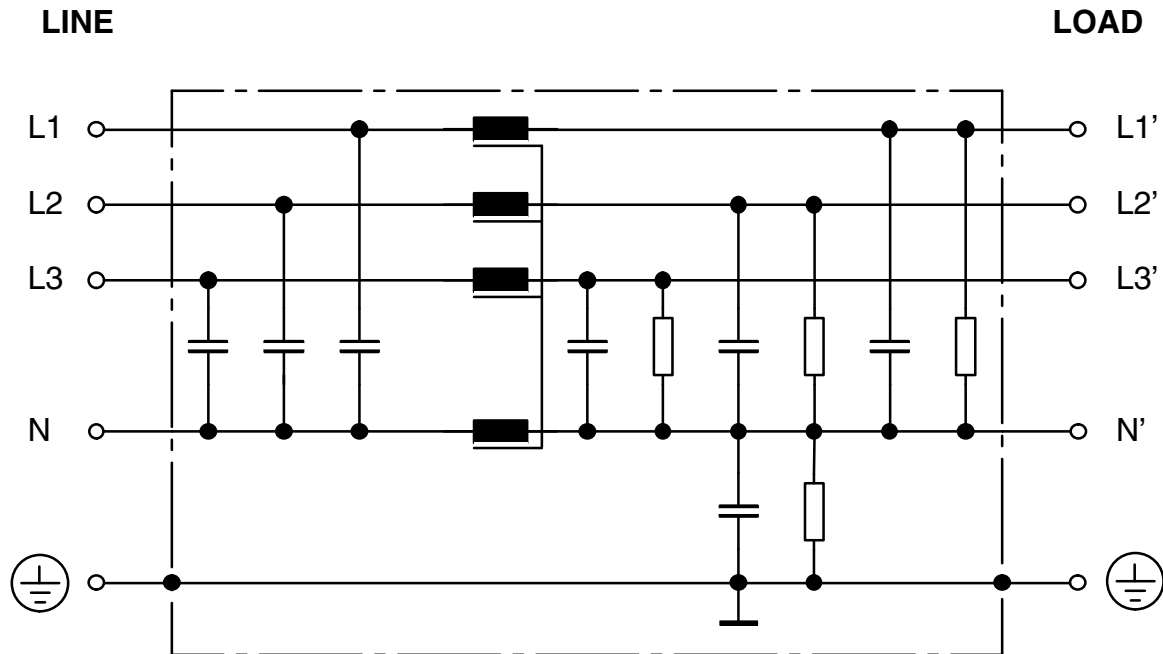

- Marking on component: manufacturer's logo, ordering code, rated voltage, rated current, rated temperature, climatic category, date code
- Minimum marking on packaging: manufacturer's logo, ordering code, date code, quantity

¹⁾ To IEC 60529:2001

Typical circuit diagram

Technical data and measuring conditions

Rated voltage	U_R	520/300	V AC
Rated frequency	f_R	50/60	Hz
Test voltage line to line for 2 s	U_{test}	2240	V DC
Test voltage line to case for 2 s	U_{test}	2720	V DC
Rated temperature	T_R	50	°C
Overload capability (thermal) for 3 min per hour or for 30 s per hour		$1.5 \times I_R$ $2.5 \times I_R$	
Climatic category (IEC 60068-1)		25/100/21	

Characteristics and ordering codes

I_R	Terminal cross section mm ²	$I_{leak}^{2)}$ mA	R_{typ} mΩ	Approx. weight kg	Ordering code	Approvals		
								
A								
8	4	<3,5	13,6	1,55	B84144A0008R120	x	x	x
16	4	<3,5	7,5	1,6	B84144A0016R120	x	x	x
25	4	<3,5	3,9	1,7	B84144A0025R120	x	x	x
36	10	<3,5	2,7	2,15	B84144A0036R120	x	x	x
50	10	<3,5	1,3	2,2	B84144A0050R120	x	x	x
66	16	<3,5	1,1	3,6	B84144A0066R120	x	x	x
90	25	<3,5	0,76	5,1	B84144A0090R120	x	x	x
120	50	<3,5	0,47	9,5	B84144A0120R120	x	x	x
150	95	<3,5	0,32	11,7	B84144A0150R120	x	x	x
200	95	<3,5	0,23	12,5	B84144A0200R120	x	x	x

X = approval granted

2) 3 phase operation in TN network; maximum voltage = U_R ; frequency = 50 Hz without harmonics; tolerance of capacitors -20%/ 0%; worst case positioning of the components; unbalance 2% according EN 50160:2000.

Dimensional drawings

B84144A0008R120
 B84144A0016R120
 B84144A0025R120

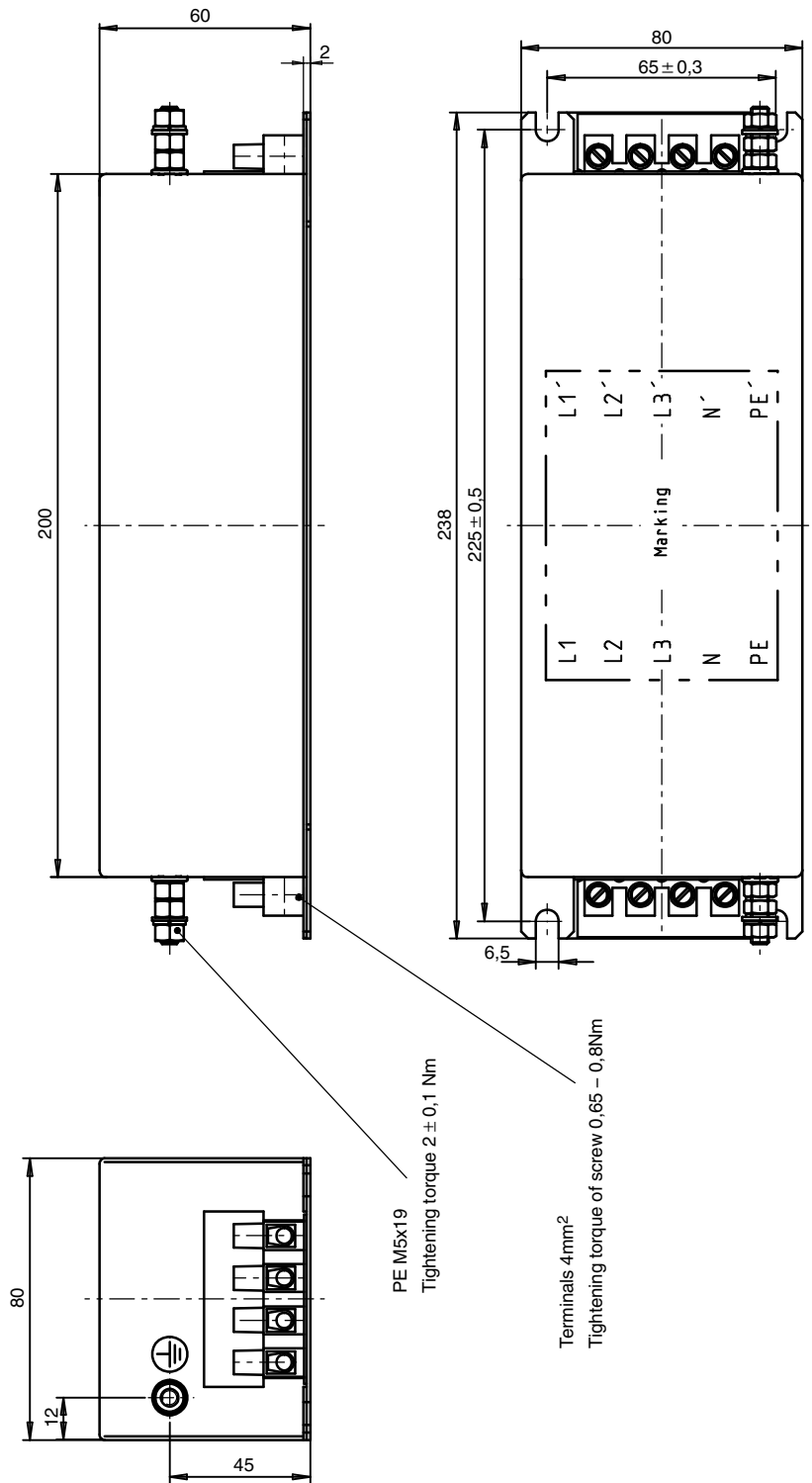

All dimensions in mm!

B84144A0036R120
B84144A0050R120

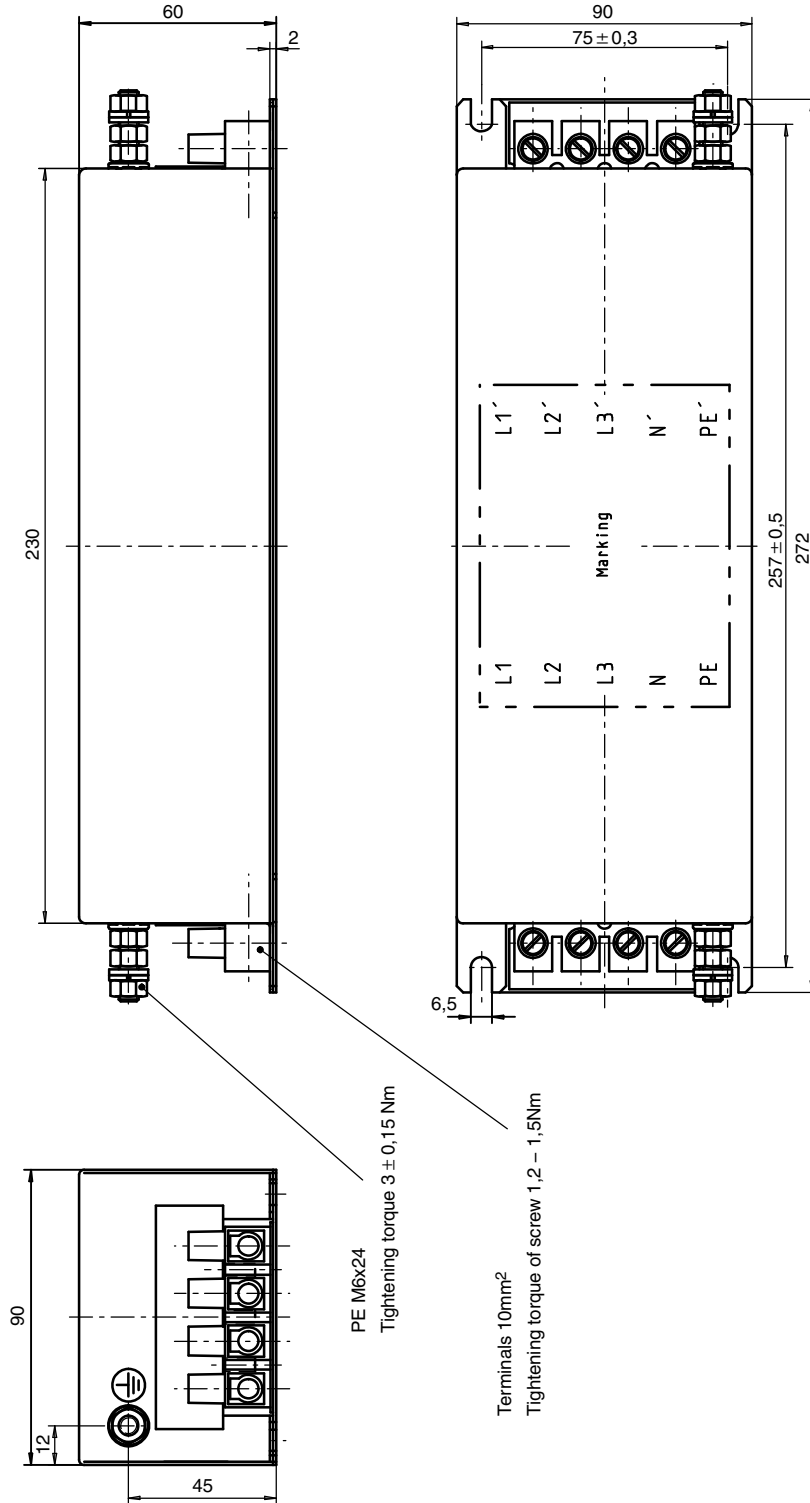

All dimensions in mm!

B84144A0066R120

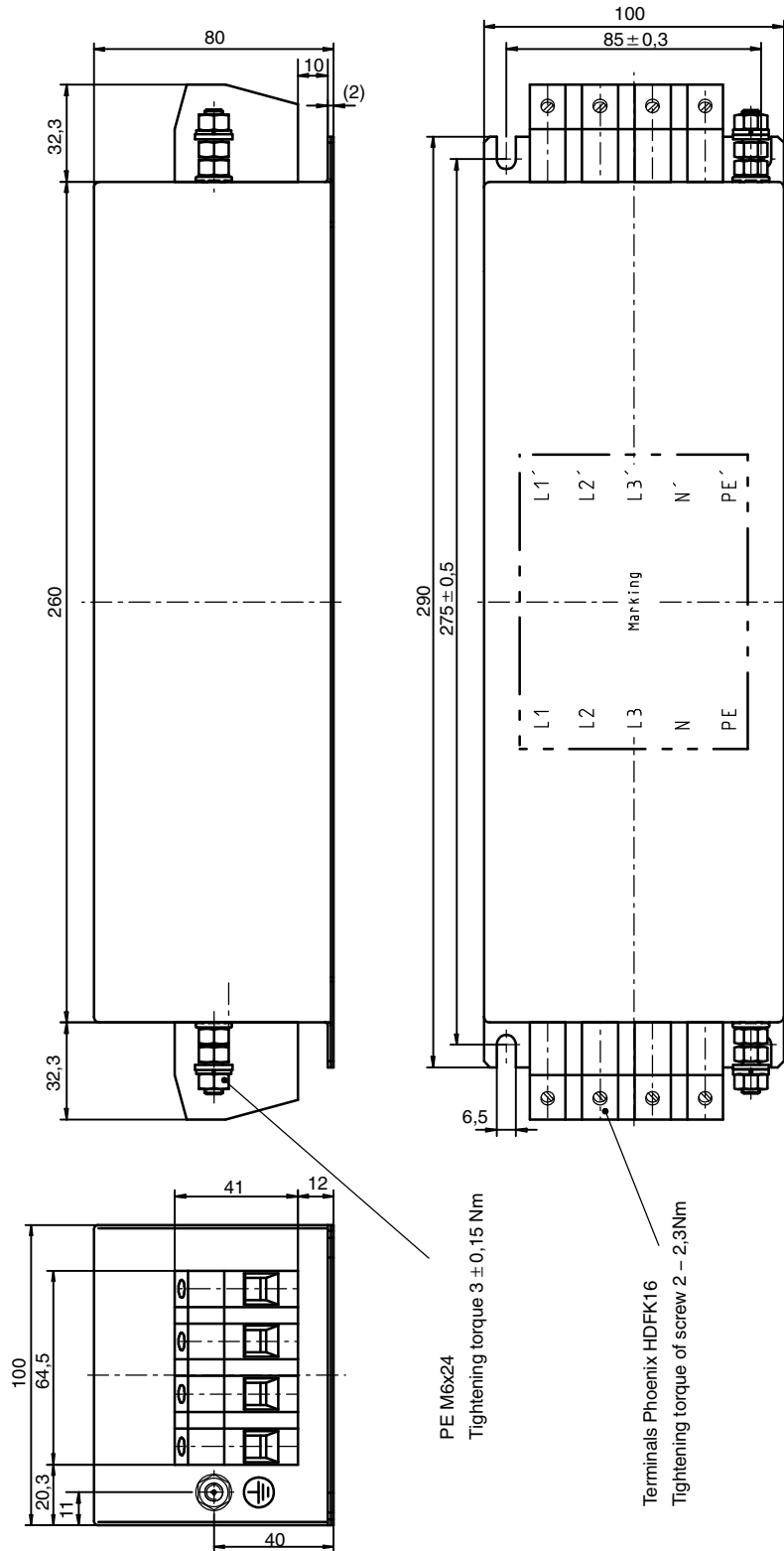

B84144A0090R120

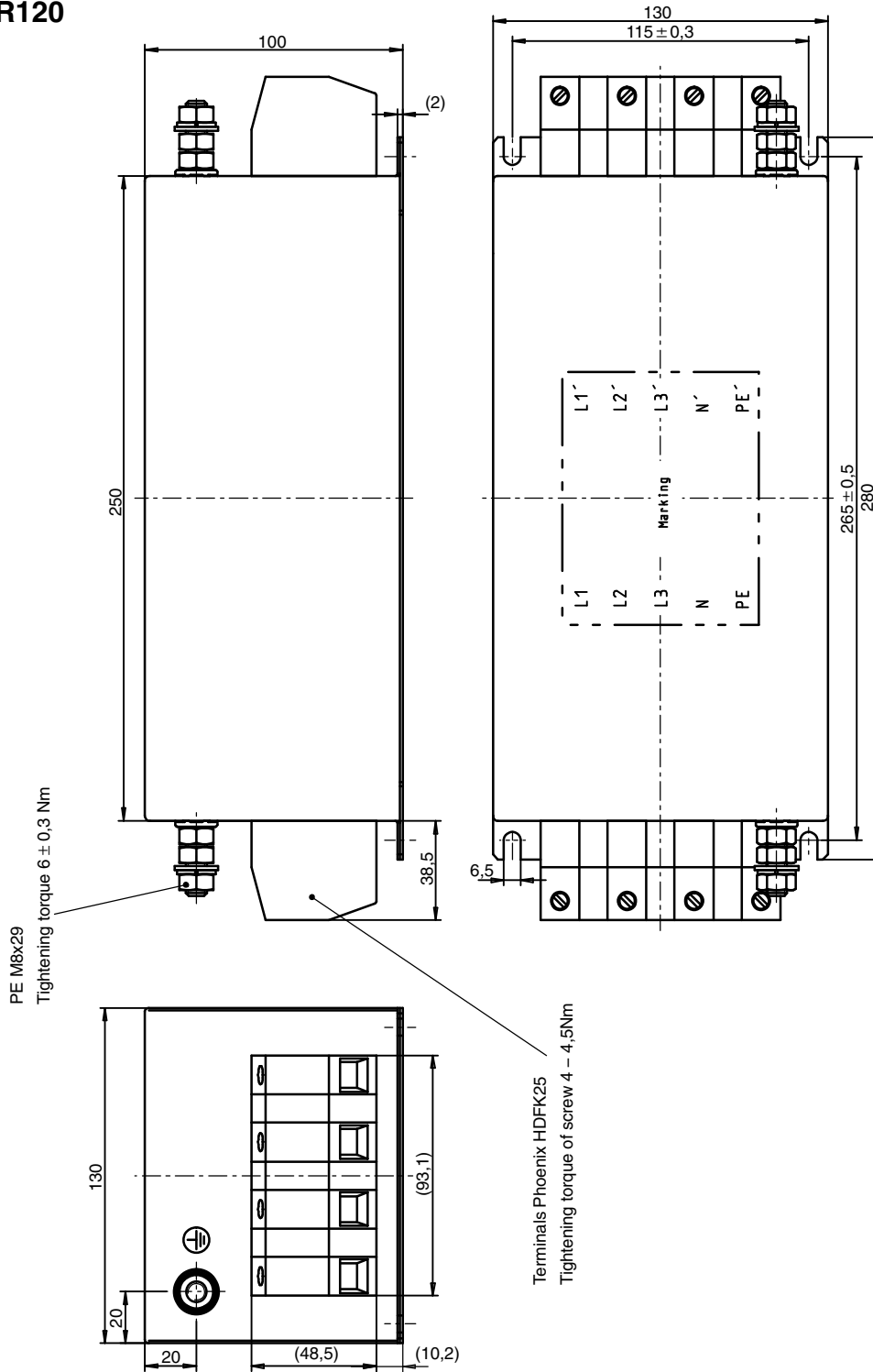

All dimensions in mm!

B84144A0120R120

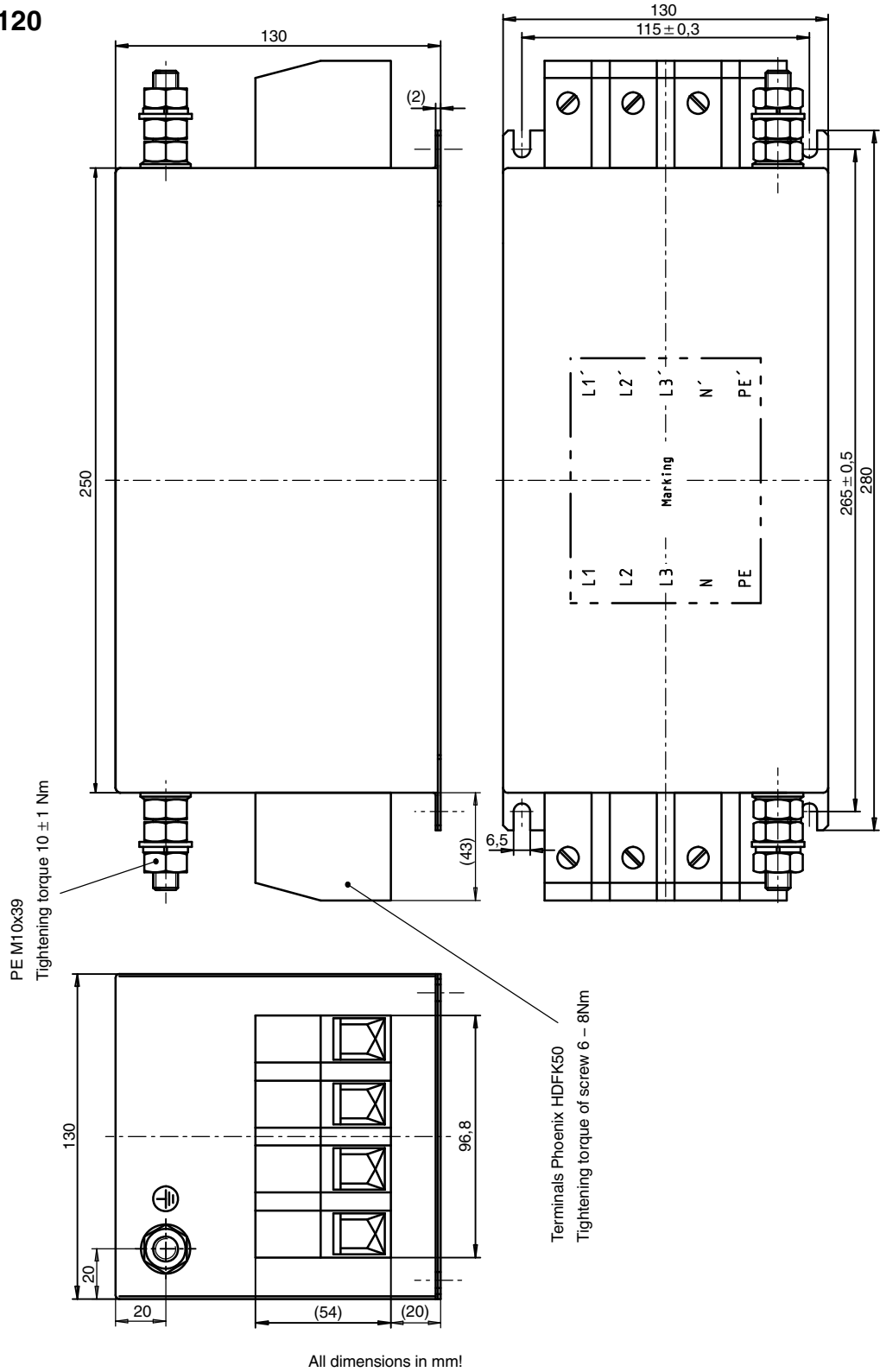

B84144A0150R120

B84144A0200R120

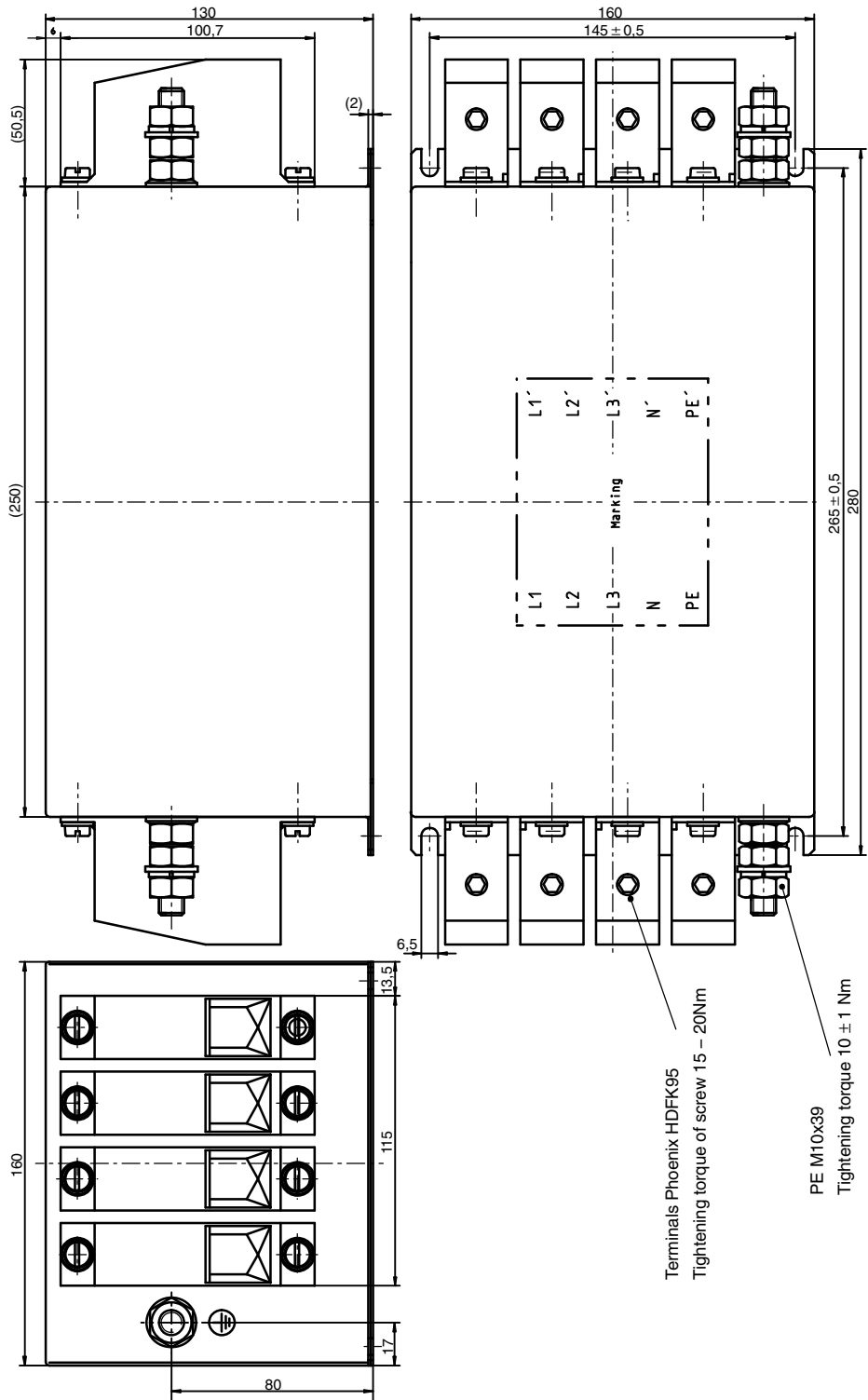

Terminals Phoenix HDFK95
Tightening torque of screw 15 – 20Nm

PE M10x39
Tightening torque 10 ± 1 Nm

All dimensions in mm!

Insertion loss (typical values at $Z = 50 \Omega$)

- unsymmetrical, adjacent branches terminated
- · - common mode, all branches in parallel (asymmetrical)
- - - differential mode (symmetrical)

B84144A0008R120

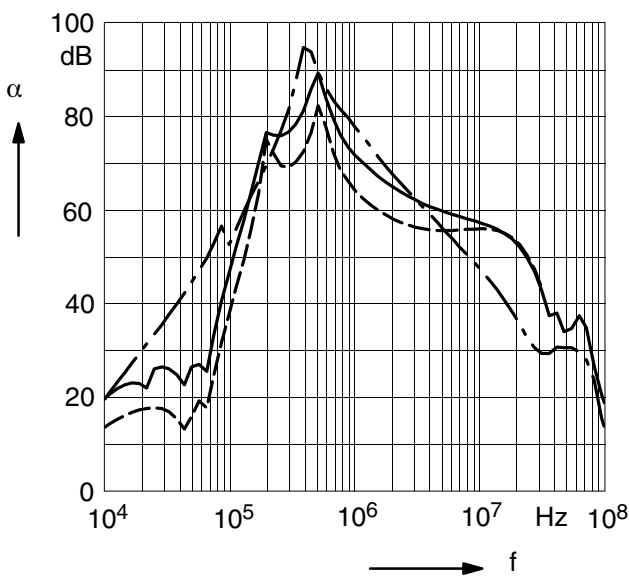

B84144A0016R120

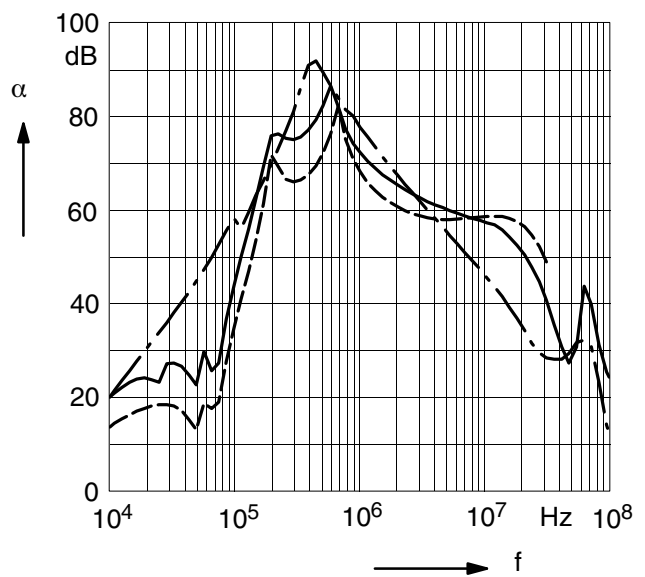

B84144A0025R120

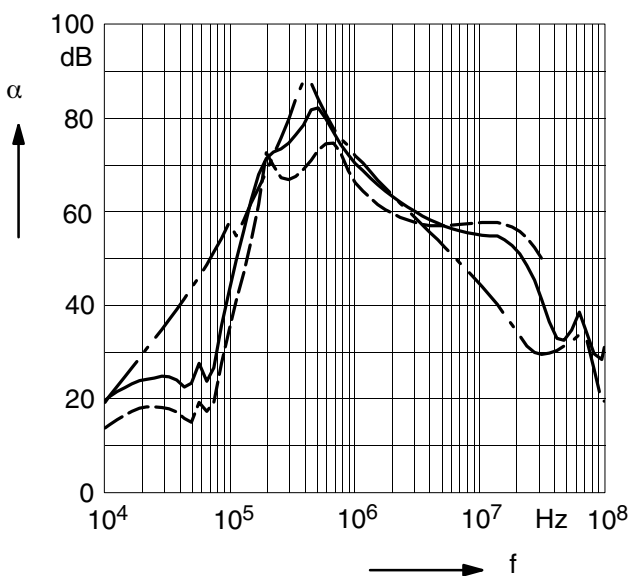

B84144A0036R120

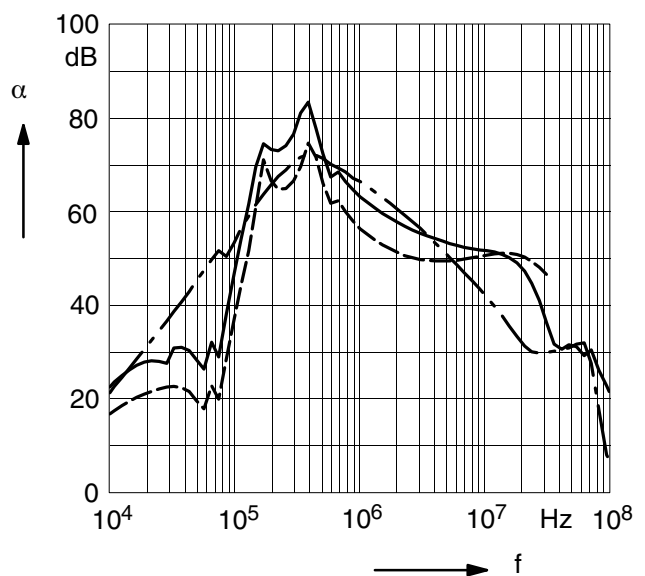

Insertion loss (typical values at $Z = 50 \Omega$)

- unsymmetrical, adjacent branches terminated
- · - common mode, all branches in parallel (asymmetrical)
- - - differential mode (symmetrical)

B84144A0050R120

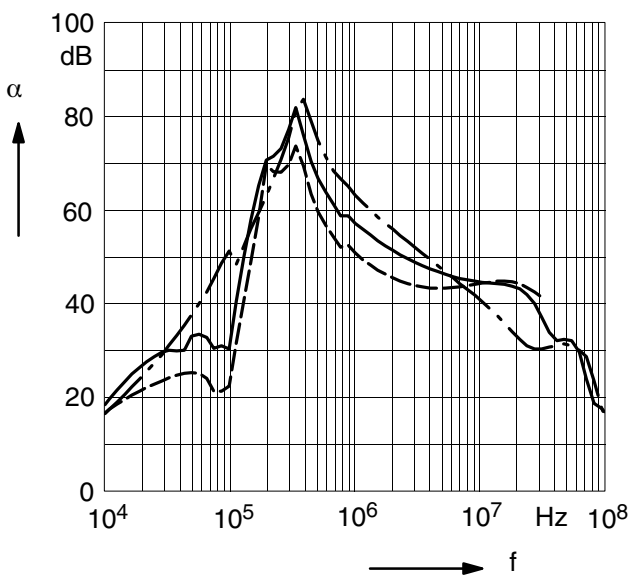

B84144A0066R120

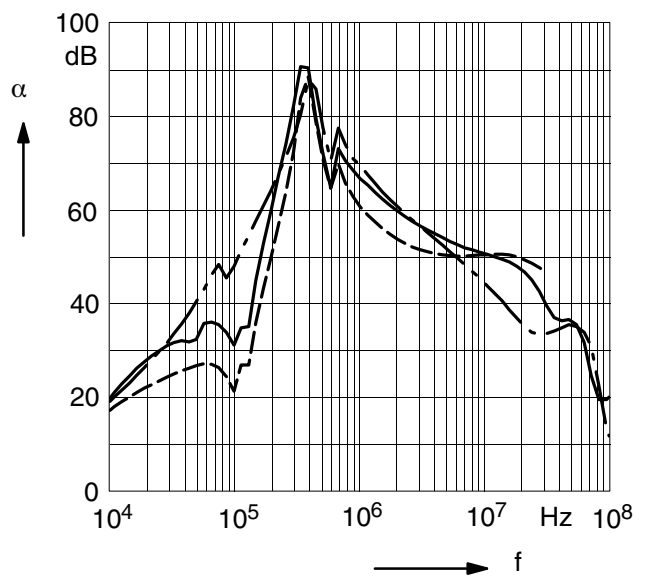

B84144A0090R120

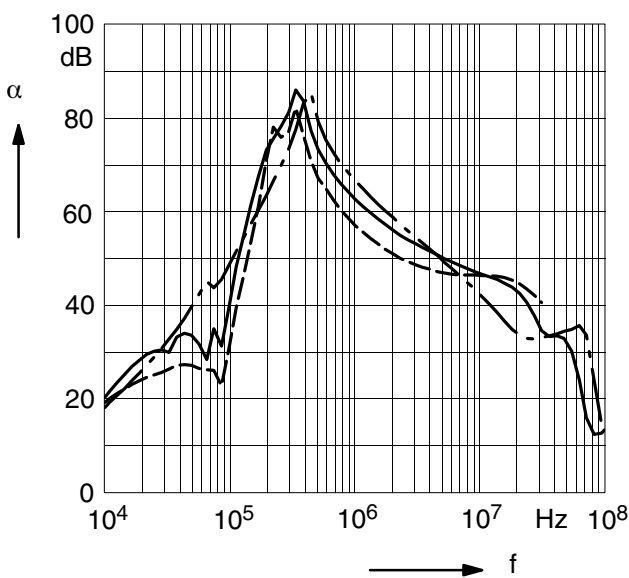

B84144A0120R120

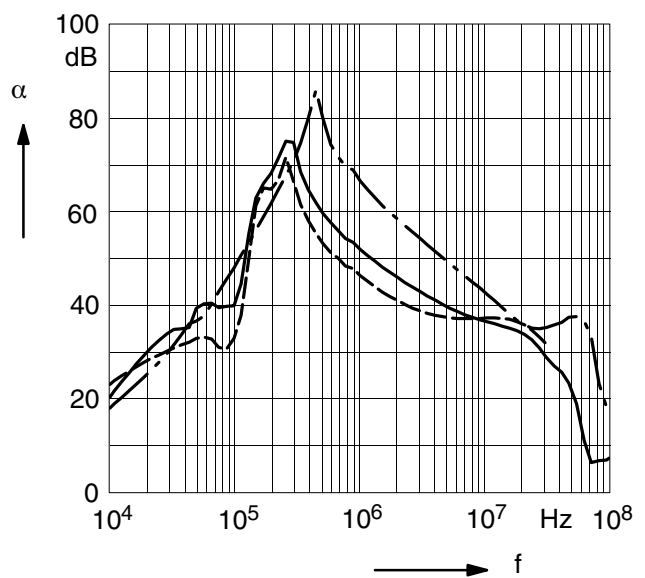

Insertion loss (typical values at $Z = 50 \Omega$)

- unsymmetrical, adjacent branches terminated
- .- common mode, all branches in parallel (asymmetrical)
- - - differential mode (symmetrical)

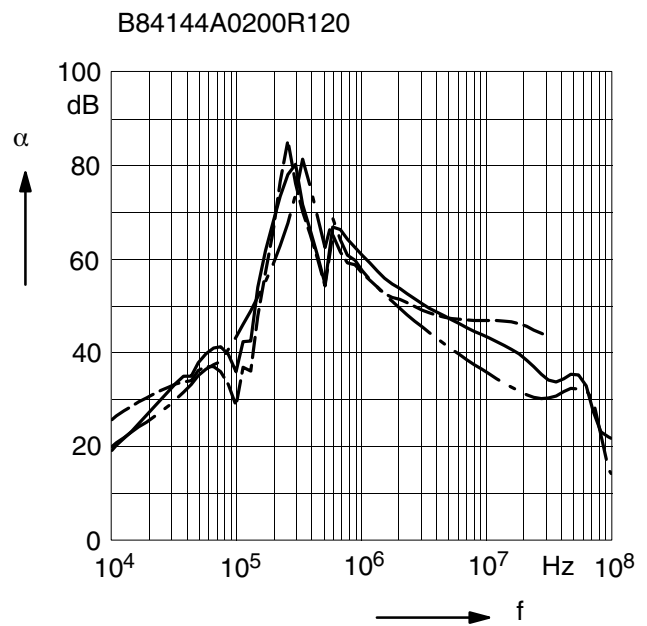
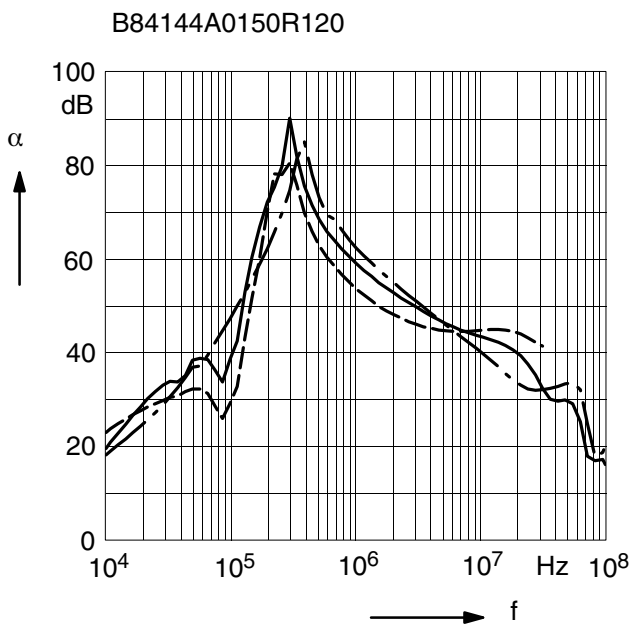

Caution and warnings

- Please note the advices in our data book “EMC Filters” (latest edition); attention should be paid to the chapter “General safety notes”.
- It shall be ensured that only qualified persons (electricity specialists) are engaged on work such as planning, assembly, installation, operation, repair and maintenance. They must be provided with the corresponding documentation.
- Danger of electric shock. EMC filters contain components that store an electric charge. Dangerous voltages can continue to exist at the filter terminals for longer than five minutes even after the power has been switched off.
- The protective earth connections shall be the first to be made when the EMC filter is installed and the last to be disconnected. Depending on the magnitude of the leakage currents, the particular specifications for making the protective–earth connection must be observed.
- Impermissible overloading of the EMC filter, such as with circuits able to cause resonances, impermissible voltages at higher frequencies etc. can lead to bodily injury and death as well as cause substantial material damages (e.g. destruction of the filter housing).
- EMC filters must be protected in the application against impermissible exceeding of the rated currents by overcurrent protective.
- In case of leakage currents $> 3.5 \text{ mA}$ you shall mount the PE conductor stationary with the required cross section before beginning of operation and save it against disconnecting. For leakage currents $I_L^{4)} < 10 \text{ mA}$ the PE conductor must have a KU value ³⁾ of 4.5; for leakage currents $I_L \geq 10 \text{ mA}$ the PE conductor must have a KU value of 6.

3) The KU value (symbol KU) is a classification parameter of safety–referred failure types designed to ensure protection against hazardous body currents and excessive heating.

A value of KU = 4.5 with respect to interruptions is attained:

– with a permanently connected protective earth circuit $\geq 1.5 \text{ mm}^2$

– with a protective earth circuit $\geq 2.5 \text{ mm}^2$ connected via shroud connectors (IEC 60309–2).

KU = 6 with respect to interruptions is achieved for fixed–connection lines $\geq 10 \text{ mm}^2$ where the type of connection and line layout correspond to the requirements for PEN conductors as specified in relevant standards.

4) I_L = leakage current let–go

Important notes

The following applies to all products named in this publication:

1. Some parts of this publication contain **statements about the suitability of our products for certain areas of application**. These statements are based on our knowledge of typical requirements that are often placed on our products in the areas of application concerned. We nevertheless expressly point out **that such statement cannot be regarded as binding statements about the suitability of our products for a particular customer application**. As a rule, EPCOS is either unfamiliar with individual customer applications or less familiar with them than the customers themselves. For these reasons, it is always ultimately incumbent on the customer to check and decide whether an EPCOS product with the properties described in the product specification is suitable for use in a particular customer application.
2. We also point out that **in individual cases, a malfunction of electronic components or failure before end of their usual service life time cannot be completely ruled out in the current state of the art, even if they are operated as specified**. In customer applications requiring a very high level of operational safety and especially in customer applications in which the malfunction or failure of a passive electronic component could endanger human life or health (e.g. in accident prevention or life-saving systems), it must therefore be ensured by means of suitable design of the customer application or other action taken by the customer (e.g. installation of protective circuitry or redundancy) that no injury or damage is sustained by third parties in the event of malfunction or failure of a passive electronic component.
3. **The warnings, cautions and product-specific notes must be observed.**
4. In order to satisfy certain technical requirements, **some of the products described in this publication may contain substances subject to restrictions in certain jurisdictions (e.g. because they are classed as hazardous)**. Useful information on this will be found in our Material Data Sheets on the Internet (www.epcos.com/material). Should you have any more detailed questions, please contact our sales offices.
5. We constantly strive to improve our products. Consequently, **the products described in this publication may change from time to time**. The same is true of the corresponding product specifications. Please check therefore to what extent product descriptions and specifications contained in this publication are still applicable before or when you place an order. We also **reserve the right to discontinue production and delivery of products**. Consequently, we cannot guarantee that all products named in this publication will always be available. The aforementioned does not apply in the case of individual agreements deviating from the foregoing for customer-specific products.
6. Unless otherwise agreed in individual contracts, **all orders subject to the current version of the "General Terms of Delivery for Products and Services in the Electrical Industry" published by the the German Electrical and Electronics Industry Association (ZVEI)**.
7. The trade names EPCOS, BAOKE, Alu-X, CeraDiode, CSSP, CTVS, DSSP, MiniBlue, MKK, MLSC, MotorCAP, PCC, PhaseCap, PhaseMod, SIFERRIT, SIFI, SIKOREL, SilverCap, SIMDAD, SIMID, SineFormer, SIOV, SIP5D, SIP5K, ThermoFuse, WindCap are **trademarks registered or pending** in Europe and in other countries. Further information will be found on the Internet at www.epcos.com/trademarks.